



TOP 50 Most Important Seating Arrangements

Directions (Q1-5) Study the following information carefully and answer the questions given below –

There are 9 members M, W, L, X, T, P, S, R, O in the family belonging to 3 generations and there are 3 married couples and one single male and two children. On one Sunday evening they decided to play cards and sit around circular table all facing center. They all like different colour viz: Black, Yellow, Brown, Magenta, Red, Violet, Green, Silver and Pink but not necessarily in same order. In one of the married couples wife is older than her husband but in remaining two couples husbands are older than their wives.

M the oldest member of the family does not like Red or green colour. One out of 3 couples is sitting side by side. L likes silver colour and is a married male. The number of members between L and R is same as that of between L and W. S is a married female and is not the one who is sitting 3rd to right of M or 3rd left of P. There are three persons sitting between O and T when counted from the right of O and does not like either Pink or black colour. The oldest male member like Pink colour. There is one daughter in law and one son in law in the family and T and X are not those. R is unmarried male and sitting fourth to the right of W. T likes yellow colour and is between R and L. R does not like violet colour. The one who likes magenta is daughter of M and wife of P. There are total 4 male members in the family and no male member in youngest generation. O does not like magenta. Daughter In law does not like brown. M is 2nd left of T and does not like violet. The person who is sitting 3rd left of oldest female likes Black. A male member likes Brown and R is not that. M's daughter and the one who likes black are sitting together. One of the two granddaughters of M likes Yellow and O is not that person. O does not like violet or Red colour. P is 2nd to the right of S. L's wife does not like black colour.

1) Who among the following likes Violet colour?

- a) W
- b) L
- c) R
- d) Either a or b
- e) Either a or c

2) What is relation between R and X?



- a) Uncle and niece
- b) Brother and sister
- c) Brother in law and sister in law
- d) Father and Mother
- e) None of these

3) Who liked green colour?

- a) P
- b) T
- c) W
- d) O
- e) Cant be determined

4) How many persons are sitting between the one who likes Magenta and the one who likes brown when counted in anti-clock wise direction from the one who likes Magenta?

- a) 3
- b) 4
- c) 2
- d) 1
- e) None

5) Which of the following represents the pair of granddaughters?

- a) OT
- b) SX
- c) SP
- d) RT
- e) TX

(Directions Q 6-15) Study the following information carefully and answer the questions given below

There are 10 friends named P, Q, R, S, T, U, V, W, X and Y. Each of them works in same company together. They all have different cars viz: Jaguar, Safari, Estilo, Zen, Maruti, Mercedes, Waganor, Sunny, i10 and Hummer but not necessarily in the same order and they also like different colours viz: Brown, Pink, Peach, Silver, Orange, White, Green, Yellow, Black and Red but not necessarily in same order. Each of them was not happy with their respective job and had a dream company viz: MaCD, Frontier, Dominoz, Apple, Microsoft, TCS, HCL, Adani, Birla and wipro, but not necessarily in same order, in which they all wish to work one day. One day they went to a hotel to have lunch and sit around a circular table with some of them facing centre and some facing outside. No two persons facing same direction sit side by side and on the evening of same day they had their board meeting in the company



in which they work and sit in two parallel rows R1 and R2 with 5 members on each side facing towards each other. R1 faces south and R2 faces north.

X likes pink colour but does not drive either sunny or safari. The one who likes Green colour sits in R1 faces the person immediate to left of one who drives Hummer. Y does not drive i10 or waganor neither he likes Peach nor white. The one who drives jaguar faces outside center in hotel and is 5th to left of one whose dream company is Wipro but does not like either orange or Yellow and P is not that person. Q's dream company is MacD but he does not like either white or red. In board meeting R is sitting in R2 is facing the who drives Sunny but does not like orange or silver and his dream company is not TCS or Microsoft. V's dream company is neither Frontier not dominoz but he likes silver colour and is sitting in R1. X, who does not drive Mercedes is facing center of the table in hotel and is 3rd to right of S who does not like estilo or Zen or Maruti. S does not like either Peach or Brown neither his dream company is Adani nor TCS. W drives sunny and faces center of table in hotel but his dream company is not TCS or HCL. The one who likes peach is sitting between R and T in hotel and Q is not that person. P drives Maruti and his dream company is not Apple or Adani neither he likes brown nor white but sitting on one of the extreme ends of R2. In hotel the number of persons between the one who likes Red and the one who drives jaguar is same as the number of person between who drives Estilo and the one who likes white. In board meeting S is sitting on extreme right end of that row and he does not like Red or black. R likes yellow. U likes orange colour and is 4th to left of one who likes pink in hotel. V drives waganor and his dream company is not Adani, Birla or Microsoft and is sitting opposite to the person who is sitting 4th to right of one who likes orange colour in hotel. T likes white colour and Y does not like estilo or jaguar but his dream company is wipro. W is on extreme left end of R1 in board meeting. R's dream company is dominoz but he does not drive Jaguar and Hummer and is on immediate right of one who likes orange in hotel. T faces outside center in hotel and is in R1 in board meeting and faces Q. W likes peach and U is between W and T in board meeting and U does not drive zen or Estilo but he wishes to work in Microsoft. P's dream company is not TCS or Birla and in hotel he is on immediate right of one whose dream company is Birla and 5th to left of one who likes orange colour. W's dream company is not Apple or Microsoft is sitting next to R in hotel. The one who drives zen is between the one who likes green colour and one who drives Maruti and R and T are not that person. Y drives Hummer is immediate neighbor of P in board meeting. T drives jaguar and U does not drive safari. V's dream company is HCL and S's dream company is not Microsoft. S drives safari. P does not like Black colour and Q does not like Brown colour.

6). Which of the following combination is correct?



- 1). P – Zen – orange
- 2). Q – Estilo – white
- 3). S – Mercedes – yellow
- 4). T – Hummer – Red
 - a) only 1
 - b) only 2
 - c) only 1 and 4
 - d) only 3 and 2
 - e) None of the given is correct
- 7). Who among the following has dream company TCS?
 - a) P
 - b) Q
 - c) R
 - d) S
 - e) T
- 8). Whose favorite colour is Brown?
 - a) X
 - b) W
 - c) U
 - d) Y
 - e) P
- 9). Who drives i10?
 - a) W
 - b) X
 - c) Q
 - d) T
 - e) None of these
- 10). How many persons face center in hotel?
 - a) 5
 - b) 4
 - c) 3
 - d) 6
 - e) Cant be determined
- 11). Which car does V drive?



- a) Maruti
- b) Zen
- c) Waganor
- d) Mercedes
- e) None of these

12). How many persons are sitting between one who drives Zen and one whose dream company is Adani when counted in clockwise direction counted from one who drives Zen in hotel?

- a) 2
- b) 3
- c) 4
- d) 5
- e) 6

13). Which of the following is dream company of S?

- a) Apple
- b) Birla
- c) Wipro
- d) Adani
- e) Cant be determined

14). One who likes Green colour drives which car?

- a) Jaguar
- b) Safari
- c) Estilo
- d) Hummer
- e) None of these

15). In board meeting who faces the one who drives Hummer?

- a) one who drives Mercedes
- b) one whose dream company is HCL
- c) one who likes Brown
- d) None of these
- e) Data inadequate

Directions (16-20) Study the information given below carefully and answer the questions given below

P, Q, R, S, T, U, V and W are eight family members who are going to attend a marriage function in Ludhiana. They attend two functions one is engagement and second is marriage. They sit around a circular table in the engagement but they sit around a rectangular table in the marriage function. In the



engagement, they wear clothes of different colour viz: Red, Blue, Orange, Green, white, Black, Purple and yellow but not in same order. In marriage function they wear clothes of different colour viz; Brown, Violet, Pink, Cream, Peach, Silver, Golden and Grey but not in same order. In engagement, four of them are facing towards the center and four of them are facing away from the center as four persons are talking to other persons by sitting facing away from the center. In marriage, three persons are sitting on the each width side and one on each length side of the table facing the center. No two person faces same direction sits adjacent to each other in the engagement. T faces towards the center and wears dress of Red colour in engagement. T sits third to the left of the person who wears dress of Silver colour in marriage. The father-in-law of P sits opposite to the person who wears dress of Brown colour in marriage. Q is the father-in-law of P. Q and U is a couple. P's mother-in-law and V are sitting opposite to each other in marriage. Both the immediate neighbors of T face away from the center and wear dress of Orange or Green colour in engagement. Q's grandchild sits diagonally opposite to the person who wears dress of Golden colour in marriage. S faces away from the center in engagement. U's daughter in-law is sitting second to the right of the person who wears dress of Grey colour in marriage. T sits third to the right of U, who is her mother and wears dress of white colour and faces away from the center in engagement. R sits third to the left of U in engagement and R is the grandchild of Q and a child of T. V does not sit diagonally opposite to the person who wears dress of golden colour in marriage. The person who wears dress of Cream colour sits second to the right of the person who wears dress of Peach colour and second to the left of P, who is not sitting near to the person who wears dress of golden colour in marriage. W's son is sitting on the length side and to the right of the person who wears dress of Golden colour in marriage. The Person who wears dress of Peach colour and the person who wears dress of Cream colour are not on the same side of the table in marriage. The one who wears dress of Orange colour sits opposite to U in engagement. The one who wears dress of Blue colour is not the immediate neighbor of U and faces away from the center in engagement. Q's grandson is sitting third to the right of the person who wears dress of Grey colour, who is not sitting diagonally opposite to the person who wears dress of either Violet or Silver colour in marriage. P sits second to the left of R and does not wear dress of Purple or Yellow colour in engagement. The one who wears dress of Purple colour sits between W and U in the engagement. And he is the son of W, who is the son of Q. Q faces away from the center and does not wear dress of Blue colour in engagement. S is the daughter-in-law of Q

16). How many male members are there in the family?

- a) 4
- b) 5
- c) 3



- d) None of these
- e) Data inadequate

17). Who is sitting opposite to P in engagement and which dress he/she wears?

- a) T, Red
- b) U, white
- c) Q, orange
- d) W, green
- e) None of these

18). Which one of the following represents one of the groups of persons sitting in opposite direction in engagement?

- a) SW
- b) SQ
- c) UV
- d) PV
- e) SU

19). Who wears peach dress in marriage?

- a) Q
- b) W
- c) R
- d) Either a or c
- e) Either a or b

20). If R is the daughter of T and P is husband of T then what relation is shared by U and T?

- a) Brother – sister
- b) Mother – daughter
- c) Father – daughter
- d) Sisters
- e) None of these

Directions (Q21-25) – Study the following information carefully and answer the questions given below-

In an apartment, a family lives with eight members i.e. E, F, G, H, I, J, K, and L. They have decided to do lunch together in a hotel and sit around a square table with all of them facing outwards. Four of them are sitting at the middle while others are sitting at the corners. All of them are equidistant from each other. Each one of them wears different colors of dress viz. Red, White, Black, Violet, Blue, Yellow, Pink and Brown. Three married couples are there in the family. All the family members are of different ages. L is the only sister-in-law of E whereas F wears Yellow dress and is a daughter-in-law of G. E, who is the



father of J and K, sits to the immediate left of the person who wears Red. J is an immediate neighbor of her aunt L who does not sit next to H. G does not wear Brown or Pink. The two youngest members sit next to each other. The one who wears the White sits between K and the one who wears Blue. K sits third to the left of H. The one who wears Yellow sits between the persons who wears Pink and Brown Respectively. H's husband and son sit next to her. K's father does not wear violet. K does not wear Black or Pink. H is the mother of E and I, and sits second to the left of I. The one, who wears Violet dress, is 65 years old. The sum of ages of G and the one, who sits directly opposite to G, is 82 years. The one who sits third to right of the one who wears white dress is 40 years. The age of the one who sits to the immediate right of E is 24 years more than from the one who wears Black dress. The 3rd left person from the one who wears Brown dress is 38 years old. The sum of ages of immediate neighbors of the one who wear Black dress is 100 years. The age of 2nd left person from the one who wears Red dress is 3 years less than from her spouse. The age of granddaughter of the one who wears Violet dress is 18 years less than from the one who wears Black dress.

21). Which of the following is the color of dress of L's brother in law?

- a) Pink
- b) Black
- c) Violet
- d) Blue
- e) None of these

22). How many persons are there between L and the one whose age is 40 when counted in clockwise direction?

- a) 4
- b) 5
- c) 6
- d) 7
- e) 3

23). Which of the following is not the correct combination?

- a) G, 65, violet
- b) H, 62 Red
- c) J, 20, white
- d) F, 40, yellow
- e) All are correct

24). Which of the following correctly represents the couple of husband and wife?

- a) HF



- b) EG
- c) IL
- d) All are correct
- e) None is correct

25). Complete the following series –

H-White-20, G-Brown-17, I-Yellow-37, _____

- a) E-Black-38
- b) F-Blue-35
- c) L-Pink-40
- d) K-violet-65
- e) None of these

Directions (26-30): Study the following information carefully and answer the given questions.

Twelve friends are sitting in two parallel rows of chairs containing six people each, in such a way that there is equal distance between adjacent persons. In row 1: Gayathri, Janani, Archana, Shalini, Devi and Deepa are seated and all of them are facing south. In row 2: Nithya, Vimala, Rohini, Bharathi, Nisha and Abirami are seated and all of them are facing north. Each of them likes different month such as, Red, Blue, Green, Yellow, Pink, Orange, Brown, Purple, Violet, Indigo, Black and Grey but not necessarily in the same order. Each of them like different sports: Cricket, Football, Tennis, Hockey, Table Tennis, Golf, Volleyball, Basketball, Rugby, Boxing, Badminton and Handball. In the given seating arrangement, each member seated in a row faces another member of the other row.

Devi, whose favourite sports is Golf sits third to the left of the person who likes Blue and not sitting at the extreme end. Janani, who likes Yellow, does not sit at an extreme end of the row. If Devi sits at an extreme end then Janani doesn't sit to the immediate right of the one who likes Blue. Rohini and Nithya face the persons whose favourite sports are Golf and Table Tennis respectively. There are two persons sitting on the right side of Vimala, who sits second to the right of the person, whose favourite sports is Boxing. Vimala, who likes Pink, faces the immediate neighbour of Gayathri. Gayathri likes Green. Nithya sits with the persons who like Pink and Grey. Deepa faces the person who likes Black and Handball sports but Deepa does not like Blue. The one who likes Grey month does not sit with the one who likes Black. The person, who likes Indigo, sits second to the right of the person who likes Orange. Bharathi does not like Black and faces the person, who likes Red. The person who likes Rugby is an immediate neighbour of the person who likes Purple. Archana's favourite sports is Hockey and she doesn't sit with Gayathri. Rohini does not like Football sports. The person, whose favourite sports is Cricket, faces the person, who sits second to the right of the person, whose favourite sports is Table Tennis. The person whose favourite sports is Basketball does not sit in row 2 and faces the person who



likes Badminton. Nisha faces the person who likes Volleyball. Archanadoes not face the person who likes Orange. The one who likes Brown sits in Row 2.

26). Who likes the Boxing sports?

- a) Nisha
- b) Nithya
- c) Abirami
- d) Rohini
- e) Bharathi

27). The one who likes Volleyballsports sits third to the right of _____

- a) Gayathri
- b) Janani
- c) Devi
- d) Deepa
- e) Archana

28). Which of the following colour likes by Nithya?

- a) Black
- b) Blue
- c) Green
- d) Orange
- e) Purple

29). Which of the following combinations is true?

- a) Deepa – Red – Tennis
- b) Devi – Orange – Golf
- c) Rohini – Indigo – Table Tennis
- d) Janani – Yellow – Basketball
- e) None of these

30). Which of the following persons sits at the extreme ends of one row?

- a) Bharathi and Nithya
- b) Nisha and Rohini
- c) Shalini and Deepa
- d) Gayathri and Devi
- e) Bharathi and Abirami

Directions (Q.31-35): Study the following information carefully and answer the questions given below.



Eight persons A, B, C, D, E, F, G and H are sitting around a square table (four of them sitting at the corner & four sitting at the middle), some of them facing the centre while some of them facing outside the centre. Each of them likes different colors viz. Red, Green, Yellow, Blue, Orange, Pink, Grey and White but not necessarily in the same order.

C is sitting fourth to the right of D. The one who likes pink color sits immediate left of D and faces the opposite direction to that of D. There are two persons sitting between A and B, who is sitting second to the left of C. F and H are immediate neighbours of C and both are facing opposite direction to that of C. B is not an immediate neighbour of one who likes pink color. One who likes yellow color sits second to the right of F. E likes white color and faces the centre of the table. The person, who likes yellow color, is sitting in between the person who likes the red color and the blue color. The one who likes yellow color does not sit in the middle of the table. H likes orange color. The one who likes grey color sits second to the left of E. Both B and G face the opposite direction to that of A. The person, who likes green color, is not an immediate neighbour of one who likes red color.

31). Who among the following faces outside the centre?

- a) B
- b) D
- c) G
- d) F
- e) C

32). Who among the following is sitting between B and C when counted in anticlockwise direction from B?

- a) The one who likes green color
- b) The one who likes grey color
- c) The one who likes orange color
- d) The one who likes pink color
- e) None of these

33). Who is sitting third to the left of H?

- a) B
- b) D
- c) One who likes blue color
- d) Either a) or c)
- e) None of these

34). If all the persons are sitting in alphabetical order starting from 'A' in a clock-wise direction, how many of them are sitting in the same place excluding 'A'?



- a) None
- b) One
- c) Two
- d) Three
- e) None of these

35). Four of the following five are form a group in some way, find out the odd one?

- a) DG
- b) BF
- c) CH
- d) EH
- e) GB

Directions (Q36-40) Read the following information carefully and answer the questions given below-

Twelve person of a family are sitting in two parallel rows containing six people each, in such a way that there is an equal distance between adjacent person. In row-1 G, H, I, J, K and L are seated and all of them are facing south. In row-2 A, B, C, D, E and F are seated and all of them are facing north. All of them sit in the chair and each of them want to eat ice-cream of different flavors i.e. Chocolate, Red velvet., Vanilla, Coconut, Butter-scotch, Apple Pie, Butter Almond, Cotton candy, Cassata, Mango, Orange and Butter pecan. Therefore, in the given arrangement each member seated in a row faces another member of the other row. The family generation is start with grandfather and end with grandson/granddaughter. There is three married couple in the family. F's mother sits third to right of F's brother. Person, who wants to eat Coconut, sits fourth to the right of the one who wants to eat Cotton candy. K is the unmarried daughter of J. Either A's wife or B's father sits at an extreme end of the line. The one who wants to eat Apple Pie faces H, who is the husband of G and wants to eat Chocolate. A is not the brother of F. The one who faces H sits second to right of E, who is the brother of B. Persons want to eat Cassata and Mango sits adjacent to each other. I's sister-in-laws does not want to eat Orange and Red velvet. Two people sit between B and B's uncle. Neither B nor F sits at an extreme end of the line. D's grandmother wants to eat Butter Almond. The immediate neighbor of K's niece (B) faces the person who sits third to left of F's sister-in-law. L's aunt faces the one, who wants to eat Mango. I and K are sister-in- laws and immediate neighbors of each other. F's maternal uncle sits second to the left of F's father. Person wants to eat Red velvet faces the one, who sits third to the left of G's daughter. I's daughter (L) faces the person who wants to eat Vanilla. K does not face the immediate neighbor of F's son. A's brother-in-law wants to eat Cotton candy. The person, who wants to eat Vanilla, faces the person, who sits third to the right of F's wife.



Person, who wants to eat butter pecan sits diagonally opposite to the person, who wants to eat apple pie. G does not eat butter almond ice cream.

36). Which of the following represents the pair of married couples?

- a) AC, JF, KB
- b) AJ, IF, HG
- c) FK, BE, GL
- d) FJ, KH, IL
- e) None of these

37). Who among the following wants to eat Butter Almond?

- a) G
- b) I
- c) J
- d) L
- e) F

38). If B is married to M then what will be E to M?

- a) Father in law
- b) Mother in law
- c) Brother in law
- d) Sister in law
- e) None of these

39). Which dish does one who faces the person who is on immediate left of J's husband eat?

- a) Butter scotch
- b) Butter pecan
- c) Orange
- d) Red velvet
- e) Chocolate

40). Who eats cotton candy?

- a) C
- b) G
- c) L
- d) K
- e) None of these

Directions (Q 41 - 45): Study the following information carefully and answer the questions given below



There are eight persons M, N, O, P, Q, R, S, T of the family, who are divided into three generations. They all are planning to go to Hotel Taj. After reaching there they sit around a circular table and order different dishes. Dishes are Paneertikka, Tandoori meatball, Manchurian, honey chilli potato, French fries, chilli tandoori chicken, MalaiKofta and Dal fry but not in same order. Also they speak three languages i.e. Italian, French and German. At least two persons speak one language but not in same order.

T speaks the same language as S, who sits third to left of N's brother and fourth to right of N. N's grandson is sitting exact opposite of N's daughter in law, who ordered Paneertikka. N's son (except T) orders chilli tandoori chicken while N orders Manchurian and speaks French language.

N has two grandchildren and two sons. Only P and Q speaks Italian and M's brother in law orders honey chilli potato and speaks German language

R is the maternal uncle of S. S's brother orders French fries. M has two sons. The persons who order Dal fry and Manchurian speak French language. P is the mother of Q and sits third to the right of Q.

T's father orders MalaiKofta and speaks French and also sits immediate right of Q, who is O's sister.

T is brother of S and O is grandson of N. O's father sits immediate left of N's daughter in law.

41). How is Q related to M?

- a) Grandson
- b) Grand daughter
- c) Wife
- d) Mother
- e) Father

42). Complete the following series based on their sitting plan

M-French-Honey chiliPotato , Q-Italian-French Fries, – O-French-Paneertikka, _____

- a) N-French-Manchurian
- b) P-Italian-MalaiKofta
- c) S-German-Dal Fry
- d) T-German-Tandoori meatball
- e) N-French-Chilli tandoori chicken

43). Which of the following represents the pair of married couples?

- a) RN , TS
- b) TN, SO
- c) RM, SP
- d) NM, SP



e) None of these

44). Which dish does Q order?

- a) Malaikofta
- b) Chili tandoori chicken
- c) Manchurian
- d) Dal fry
- e) Tandoori Meatbaal

45). Which of the following pairs speak Italian?

- a) PQ
- b) MP
- c) QO
- d) TR
- e) None of these

Direction (46-50):

L, M, N, O, P and Q are six friends who are pursuing B tech in electrical engineering. They study in Guru Nanak Dev Engineering college, Ludhiana. They are all sitting in the Playground in a circle facing to the centre. They are discussing about their marks which they got in the 4th semester. They study 6 different subjects in 4th semester viz; Power electronics, Electrical machine, Power system, Electric Drive, Material Science, and Network system, but not necessarily in the same order. They got different marks in each subject but highest marks in each one of the subject of a maximum of 100 marks. (Marks are an integer value). N is second to the right of the person, who got highest marks in Material Science, who got 69 marks which was the third lowest marks out of the highest marks of 6 students. L is immediate left of the person who is opposite to the person who got highest marks in Network system, who is not near to Q. M got the 2nd highest marks among the highest marks of them and did not get it in Electric drive but sits second to the left of the person, who got 74 highest marks. O is seated opposite to one who got highest marks in Electric Drive. O is not near to M. P has not got the lowest marks among the highest marks of them. N sits immediate left of the one who got highest marks in Network system and N got 70 as his highest marks. The person who got highest marks in Electrical machine is second to the left of the one who got 72 marks as highest. The person who got highest marks in Power electronics did not get the highest among the highest marks of all of them. One of the six students got highest marks which was a prime number. The lowest highest marks among them are 64

46) which of the following combination is wrong?

- a) M – 72 – Network System
- b) – 64 – electrical machine



- c) P – 67 – electric device
- d) L – 70 – power electronics
- e) All are correct

47) Who has got highest marks in power system?

- a) L
- b) P
- c) Q
- d) O
- e) None of these

48) M has got the highest marks in which of the following subjects?

- a) Power Electronics
- b) Electric device
- c) Electric machine
- d) Power device
- e) Network System

49) Which of the following pair represents the pair of persons sitting opposite to each other?

- a) LP
- b) OQ
- c) NL
- d) MN
- e) Cannot be determined

50) Complete the following series

M-70-Electric Machine, N-64-Material Science, O-69-power system, ___-___-_____

- a) P-72-power electronics
- b) L-67-network system
- c) Q-74-Electric device
- d) Q-67-power electronics
- e) None of these

Solutions

Direction (1-5)

Blood Relation



Person	Car	Colour	Dream company
P	Maruti	Red	Frontier
Q	Zen	Black	MacD
R	Estilo	Yellow	Dominoz
S	Safari	Green	Apple
T	Jaguar	White	TCS
U	Mercedes	Orange	Microsoft
V	Waganor	Silver	HCL
W	Sunny	Peach	Adani
X	i10	Pink	Birla
Y	Hummer	Brown	Wipro

In hotel

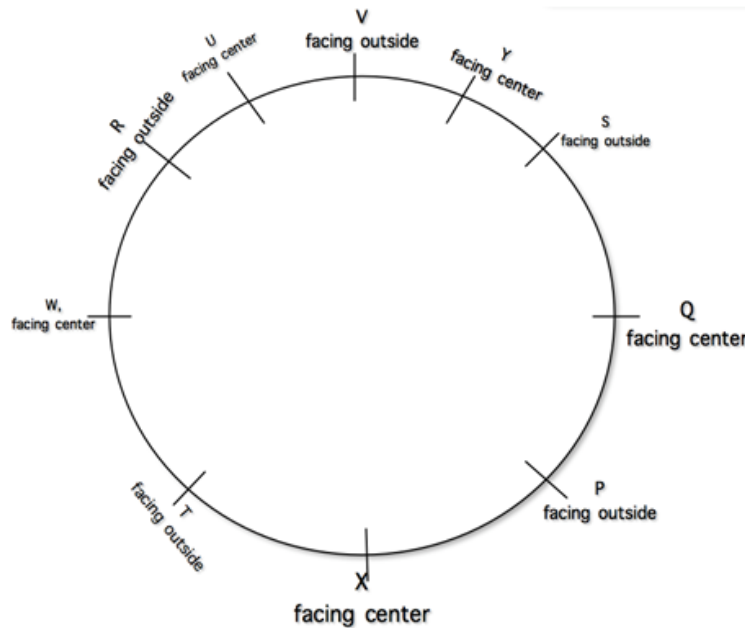

In board meeting

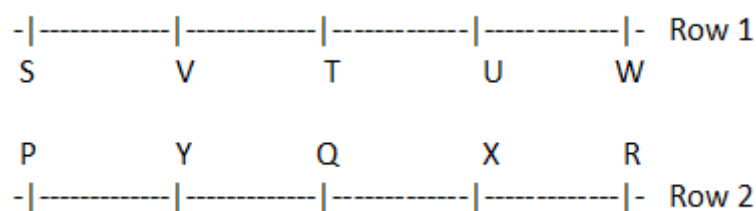



6). E) 7). E) 8). D) 9). B) 10).A) 11).C) 12).B) 13).A) 14).B) 15). B)

Direction (16-20):

In engagement

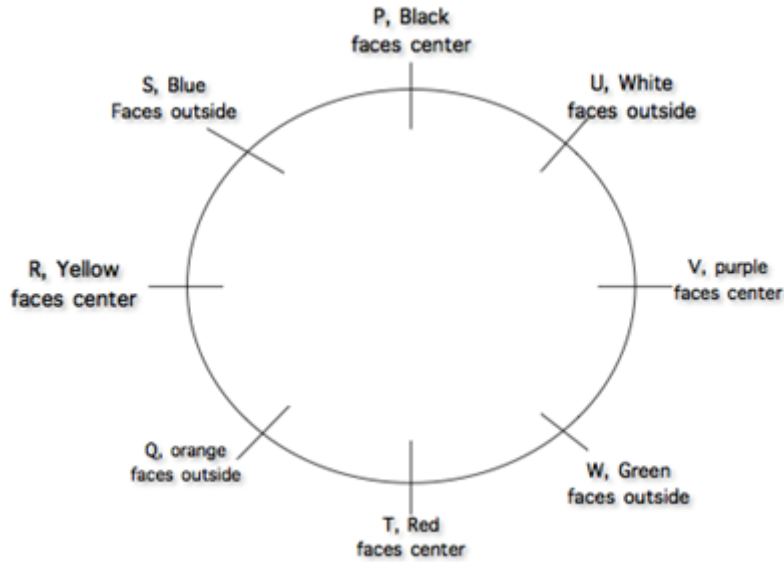

In Marriage

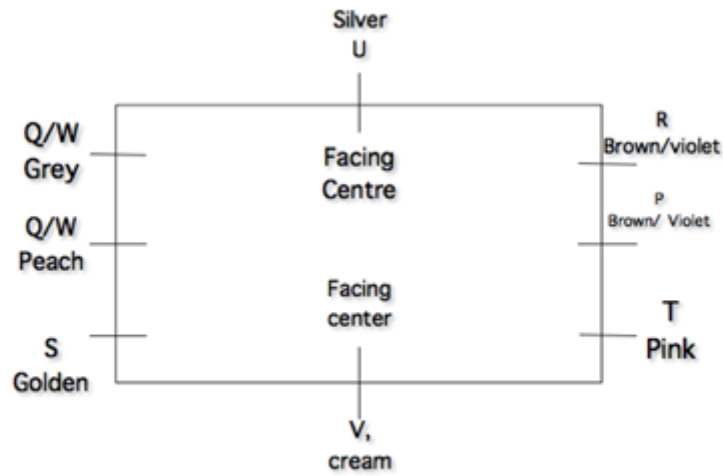

Blood relations

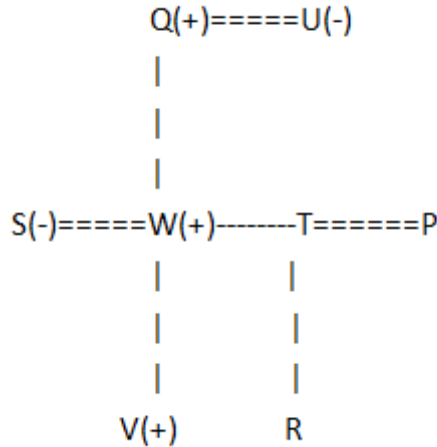

16). E) 17).A) 18).C) 19).E) 20). B)

Directions(21-25):

Explanation:

Direction (1-5)

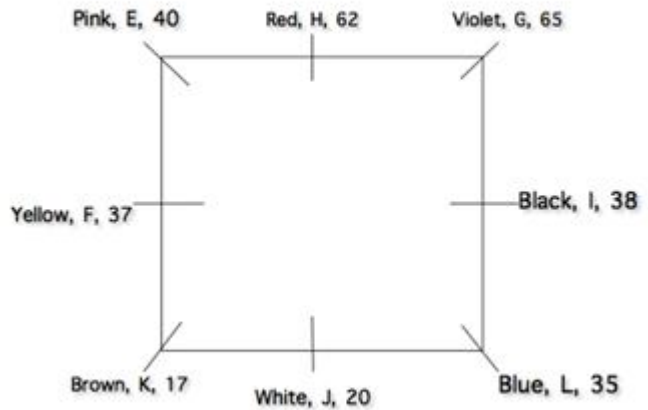
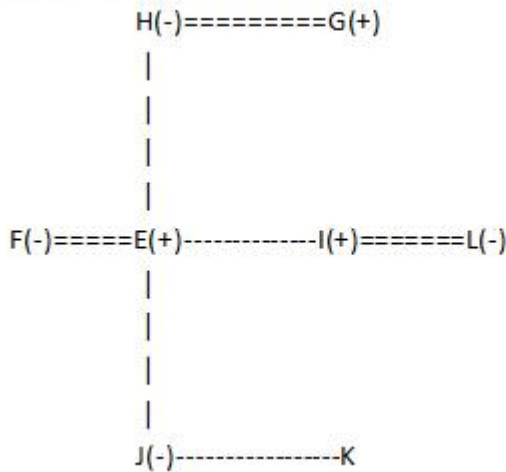

21). A) 22).E) 23).D) 24).C) 25). C)

Explanation:

Direction (26-30)

Facing South	Archana (Red) (Hockey)	Shalini (Blue) (Volleyball)	Gayathri (Green) (Table Tennis)	Janani (Yellow) (Basketball)	Devi (Purple) (Golf)	Deepa (Violet) (Rugby)
Facing North	Bharathi (Brown)	Nisha (Grey)	Nithya (Orange)	Vimala (Pink)	Rohini (Indigo)	Abirami (Black)



	(Cricket)	(Boxing)	(Football)	(Badminton)	(Tennis)	(Handball)
--	-----------	----------	------------	-------------	----------	------------

26). A) 27).C) 28).D) 29).D) 30). E)

Direction (31-35)

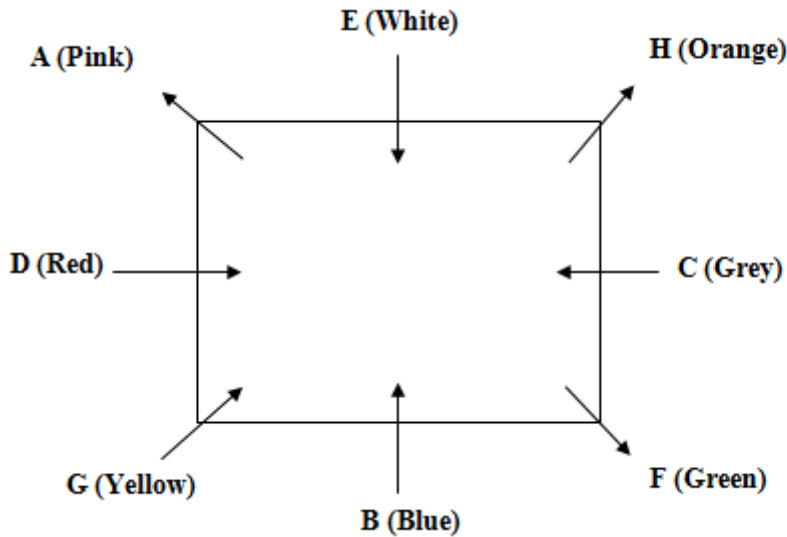

'F' faces outside the center.

31). D) 32).A) 33). B)

34). B)

one i.e. 'G' is remaining in the same place.

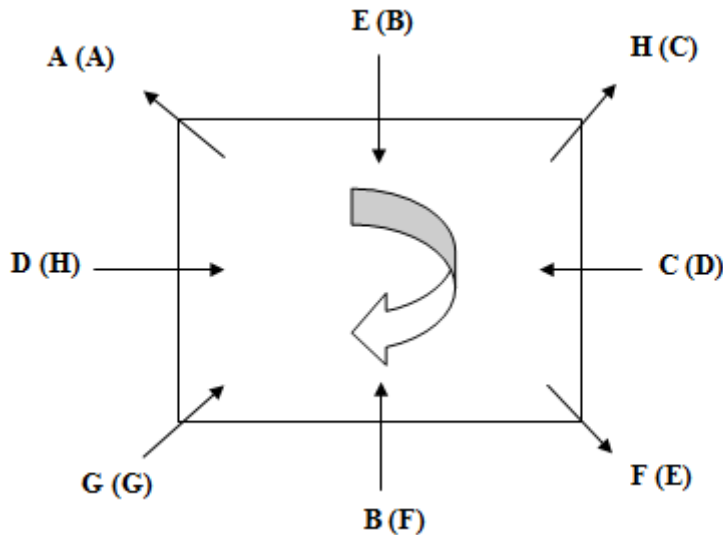

35). D)

Second person is sitting immediate right of the first person but in option d) second person is sitting immediate left of the first person. Hence, 'EH' is odd one.

Directions(36-40):

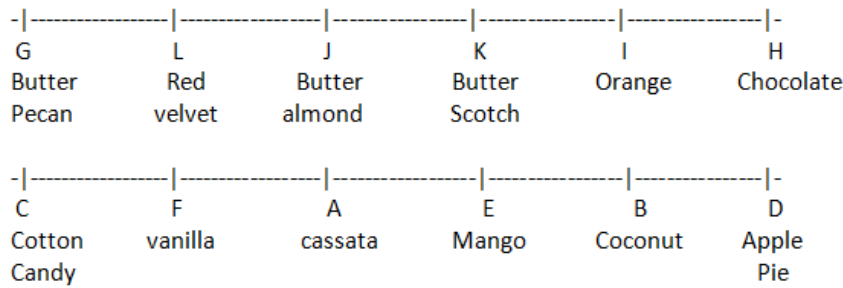
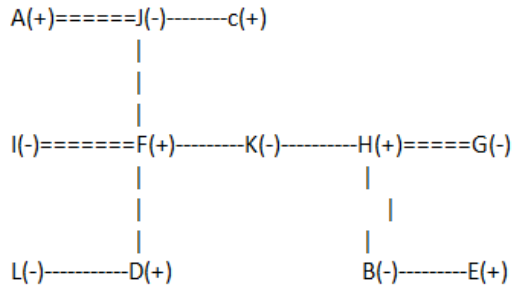

36). B) 37).C) 38).C) 39).D) 40). A)

Direction (41-45):

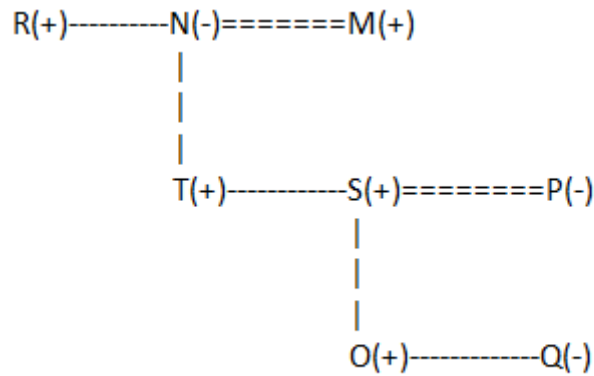

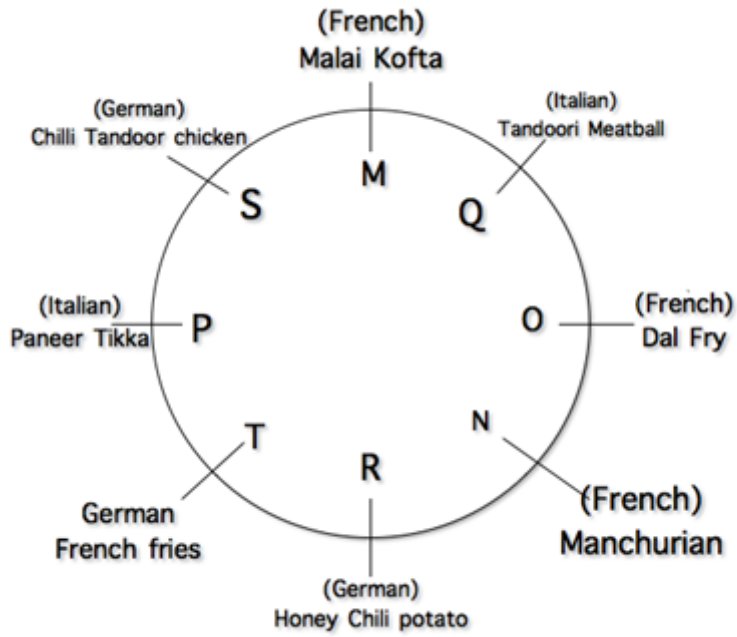

41). B) 42).E) 43).D) 44).E) 45). A)

Direction (46-50):

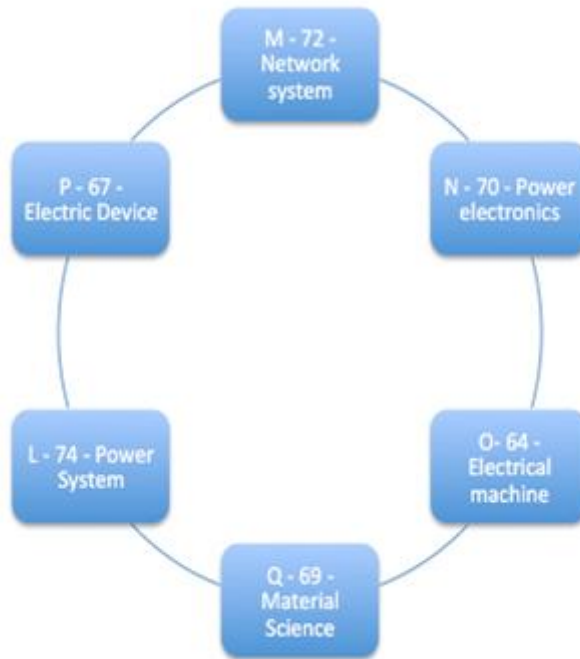

46). D) 47).A) 48).E) 49).C) 50). C)



IBPSGuide.com

TOP 700
English Questions
eBook

New Edition
2017

With Detailed
Explanation
Crack
IBPS PO/Clerk/RRB

100% Satisfaction Guaranteed

Purely Based on New Pattern

Topics Covered:

- Choose the Appropriate Sentence
- Combining Sentence
- Error Spotting
- Fill in the Blanks
- Odd One Out
- Sentence Improvement
- Sentence Rearrangements

Free 1000 Important
English Vocabulary words
from Hindu Newspaper

MUST DO - Practice Puzzles eBook

100 Questions

Exactly Based on SBI PO Mains Level

A2Z
Quantitative Aptitude
eBook

IBPS RRB/PO/Clerk 2017

Reasoning Ability eBook

VERIFIED

Exclusively on New Pattern

Data Interpretation eBook

Exclusively on New Pattern

2017 Special Edition

A2Z
Banking Awareness eBook

Especially for IBPS RRB/Clerk/PO 2017-18

VERIFIED

Covered All Important Topics